

DIGITAL STROBOSCOPE

Model : DT-2239A



Your purchase of this DIGITAL STROBOSCOPE marks a step forward for you into the field of precision measurement. Although this STROBOSCOPE is a complex and delicate instrument, its durable structure developed. Please read the following instructions carefully and always keep this manual within easy reach.

OPERATION MANUAL

Warning

Do not look directly at strobe/reflector.
Light pulses at the frequency greater than 5 Hz may cause photosensitive epilepsy in some individuals if directly viewed.

A feature of the instrument is to make moving objects appear to be stationary. Precaution should therefore be taken to ensure that there is no physical contact made with objects being viewed.

Caution Symbol

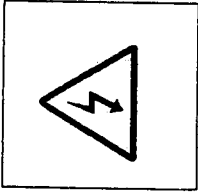

Caution :

* Risk of electric shock !

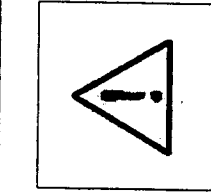

Caution :

- * Do not use fingers or any tool to touch the FLASH TUBE.
- * The instrument contains no user serviceable parts and should not be opened by the user.
- * Repair or after service should be done by a qualified technician only.
- * Power plug should apply the correct ACV power voltage
- * Operating duty cycle should be adhered to.
- * Cleaning - Only use the dry cloth to clean the plastic case !

Environmental Condition

- * Comply with EN61010 Installation category II 300 Vac.
- * Pollution Degree 2.
- * Altitude up to 2000 meters.
- * Indoor use.
- * Relative humidity 80% max.

TABLE OF CONTENTS

1. FEATURES.....	1
2. SPECIFICATIONS.....	1
2-1 General Specification.....	1
2-2 Flash Tube Specification.....	2
3. FRONT PANEL DESCRIPTION.....	3
3-1 Power On/Off Switch.....	3
3-2 Low/High Range Select Switch.....	3
3-3 Fine Adjust Knob.....	3
3-4 Coarse Adjust Knob.....	3
3-5 Flash Tube.....	3
3-6 Auto Range Indicator.....	3
3-7 Display.....	3
3-8 Power Cord Input Socket.....	3
3-9 Power Cord Connector.....	3
3-10 Power Cord Plug.....	3
4. MEASURING PROCEDURES.....	4
4-1 Preparation.....	4
4-2 Checking Speed.....	4
4-3 Checking Motion.....	5
5. FLASH TUBE REPLACEMENT.....	5
6. THE ADDRESS OF AFTER SERVICE CENTER.....	6

1. FEATURES

The Digital Stroboscope is a microprocessor circuit design, high accuracy, digital readout, light duty, that is ideal for inspecting and measuring the speed of moving gears, fans, centrifuges, pumps, motors and other equipment used in general industrial maintenance, production, quality control, laboratories and as well as for schools and colleges for demonstrating strobe action.

2. SPECIFICATIONS

2-1 General Specification

Display	0.4" LED, 4 digits.
Stroboscopic Flash Rate	100 to 10,000 flashes per minute (FPM).
Accuracy	(0.05% + 1 digit). * Spec. tested under the environment RF Field Strength less than 3 V/M & frequency less than the 30 MHz only.
Resolution	0.1 FPM/RPM (less than 1,000 FPM/RPM) 1 FPM/RPM (1,000 to 9,999 FPM/RPM). 10 FPM/RPM (over 10,000 FPM/RPM)
Sampling Time	1 second.
Range Select	High/Low range Low range : Approx. 100.0 to 1,200 RPM High range : Approx. 1,000 to 10,000 RPM
Circuit	One chip of microcomputer LSI circuit & crystal control time base

3. FRONT PANEL DESCRIPTION

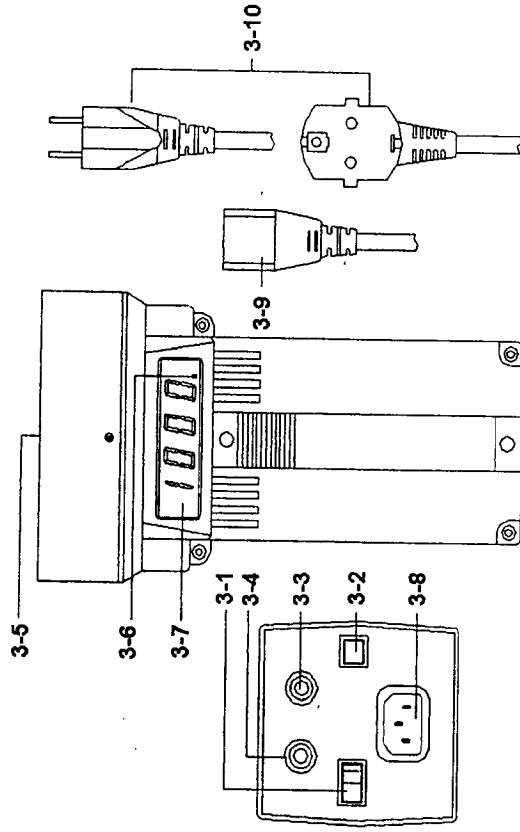

Symbol :

1 = On
0 = Off

Fig. 1

- 3-1 Power On/Off Switch
- 3-2 Low/High Range Select Switch
- 3-3 Fine Adjust Knob
- 3-4 Coarse Adjust Knob
- 3-5 Flash Tube
- 3-6 Auto Range Indicator
- 3-7 Display
- 3-8 Power Cord Input Socket
- 3-9 Power Cord Connector
- 3-10 Power Cord Plug

Power Supply	110 Vac 10%, 50/60 Hz.
	220 Vac 10%, 50/60 Hz.
	230 Vac 10%, 50/60 Hz.
	240 Vac 10%, 50/60 Hz.
Power	Less than 30 Watt.
Consumption	
Operating Temp.	0 to 50 °C (32 to 122 °F).
Operating Humidity	Less than 80% R.H.
Dimension	21 x 12 x 12 cm (8.3 x 4.8 x 4.8 inch).
Weight	1 Kg/2.2 LB.
Housing	Compact and impact plastic injection case with plastic mirror type reflector.
Calibration	Crystal time base and microprocessor circuit, no external calibration process required.
Accessories Included	Operation manual.....1 PC
	Power cord.....1 PC

2-2 Flash Tube Specification

Flash tube	Xenon lamp.
Flash Duration	Approximately 60 to 1000 microseconds.
Flash color	Xenon white 6,500 K degree.
Flash energy	4 Watts-seconds (joules).
Beam Angle	80
Flash tube replacement	It may be necessary to change the xenon flash tube if the instrument starts to flash irregularly at speeds of 3600 RPM/FPM or more.
Operating duty Cycle	For prolonged life and safe operation, please adhere to the following duty cycle : Below 3,000 RPM - 30 Minutes. Above 3,000 RPM - 5 Minutes. * Always allow a 10 minute cooling off period between cycles.

4. MEASURING PROCEDURE

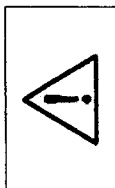

Caution :

- * Do not use fingers or any tool to touch the FLASH TUBE.

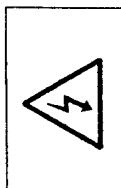

- * Risk of electric shock !

4-1 Preparation

- Connect the " Power Cord Connector " (3-9, Fig. 1) to the " Power Cord Input Socket " (3-8). Plug the " Power Cord Plug " (Fig. 1, 3-10) into a properly grounded 110V AC, 220V AC or 240V AC outlet.

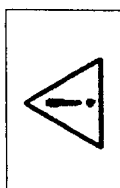

Caution :

- * The power plug should be connected to the correct AC power supply.

- Turn the power switch to " On " position.
- Determine the range switch to "Low" or "High" position.

4-2 Checking Speed (RPM/FPM)

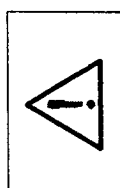

Caution :

- * Operating duty cycle should be followed.

For prolong life and safety, please adhere to the following operation duty :

- Below 3,000 RPM - 30 Minutes.
- Above 3,000 RPM - 5 Minutes.

* Always allow a 10 minute cooling off period between cycles.

- Power off the installation to be measured, make a " mark " on the rotation area where it is intended to measure the RPM. Then power on the installation to be measured.

- When checking the speed, care must be taken to ensure that the strobe is flashing in unison (one to one) with the object being monitored. Turn the " Fine Adjust Knob " (3-3, Fig. 1) or " Coarse Adjust Knob " (3-4, Fig. 1) until the mark look like " Stop " (synchronize).
- The Stroboscope will also stop motion at 2:1, 3:1, 4:1 et., this is normally referred to as harmonics. To ensure unison, turn the dial until two images appear - this will double the actual speed. Then lower the flashing rate until a single and stationary image appears - this is the actual true speed.

4-3 Checking Motion

For motion analysis, simply locate the actual speed as mentioned above and then turn the dial slowly up or down. This will give a slow motion effect allowing complete inspection.

5. FLASH TUBE REPLACEMENT

The flash tube requires changing when the instrument start to flash erratically at speeds of 3600 RPM/FPM or more.

Caution :

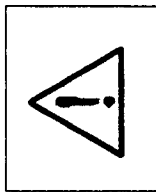

- * Change of the Flash Tube should only be done by a qualified technician. As the instrument contains no user serviceable parts.